

FINE GRINDING EXPERIENCE WITH VERTICALLY STIRRED BALL MILLS

BARIŞTIRMA DEĞİRMENLERİNDE İNCE ÖĞÜTME TECRÜBESİ

Kjell I. Holmberg *
Lars J. Lidström **

Keywords : Fine Grinding, Stirred Mills

ÖZET

Zayıf ve ince öğütülmüş cevherlerin işlenmesi, - 50 /Am mertebesinde, daha etkin bir öğütme metodunun araştırılmasını gerektirir.

Bu bildiri, karıştırma (düşey kanşbrmalı bilyalı) değirmen dizaynı ve küçük öğütme elemanı kullanımında, klasik devirme değirmenlere kıyasla çok mükemmel olan bulguları rapor etmektedir.

ABSTRACT

Treatment of ever more lean and fine-grained ores has necessitated investigations of more efficient grinding methods in the - 50 /µm range.

This paper reports our findings from using a stirred ball mill design and small grinding media, with excellent results in comparision with conventional tumbling ball mills.

DENVER - SALA, S- 73325, Sala, Sweden
ScanPlan, Box 1512, S-172 29, Sunbyberg, Sweden

TÜRKİYE XML MADENCİLİK KONGRESİ, 1993

1 INTRODUCTION

As already mentioned in the abstract, the demand for finer grinds, even down to micron or submicron sizes, has increased in general, but also very much so for the industrial and metallic minerals industry.

It is also well known that the industrial "work horse" for fine grinding, the wet or dry ball mill, for various reasons, becomes more and more inefficient for sizes less than k80 75 //m, and especially considering sizes less than k80 45 pm.

Since breaking/crushing of the particles propagates by cracking in the inherent weaker planes of the particles (micro-cracks, inhomogeneities etc) by predominantly compression forces, this gets more and more difficult with decreasing particle sizes. The simple reason for this is that the number of above mentioned faults per particle also decreases with decreasing size, making them able to withstand the compressive forces applied by the media. Also the vastly increasing number of particles makes it less and less probable to be subjected to a "direct hit" between two balls.

Instead the particles should be broken by shearing forces, since part of such will be of tensile type. All solids have much smaller resistance to tensile than to compressive forces, as we all know. The problem is to apply such forces to very many and small particles!

From the above is then evident that for efficient fine and very fine grinding of solids, either very high compressive forces of a particle bed, or intense stirring with small grinding media must be used.

The German development of high-pressure roller mills is an example of the first principle, while mechanically stirred ball mills will be of the second type.

Obviously we will in this paper be concentrating entirely on the agitated (or with another name "vertically stirred ball ") mill type.

2. STIRRED BALL MILLS HISTORY AND DEVELOPMENT

This mill type is for sure not new, since the original patents date back to 1928. However, until recently it was basically used for low capacity, non-abrasive applications, such as colour pigment or talc fine grinding e.t.c.

Although the good power efficiency of these mills was recognised by a few mining people, they were not considered as a serious alternative. The two crucial reasons for this were the relatively small available sizes and powers, but most of all, the anticipated lacking wear resistance. Industrial and metallic minerals are notoriously abrasive and the concentrators operate continuously, demanding high availability for all machines involved.

In our company we realized the upcoming demand for more fine grinds, and as manufacturers of all types of tumbling mills we were well aware of the shortcomings of these in that respect. Together with Dr. Lars Lidsrom, associated professor at the Luieâ University, and co-author of this paper, we investigated the possible candidates for new mill developments, and selected the vertically stirred ball mill as the most suitable.

Since we were used to deal with high-wearing environments, we believed that we should be well suited to solve any wear problems. This work started in 1986 with a basic prototype, which today is completely changed in most respects!

As a matter of fact, most of the time so far has been spent by making small modifications in order to combat the wear. We will not go into any details here on the mechanical design otherwise than those relevant to the optimum operational parameters realized from intermediate lab and pilot tests.

3.0PERATING FUNDAMENTALS

Since a certain minimum stirring speed is necessary in order to achieve sufficient shearing forces, the grinding chamber should be in the form of an annulus, the narrower the better. However, a compromise in this respect is necessary, in order to keep mill sizes and prices viable.

A design with a small diameter rotor shaft and long stirring pins will thus have very varying stirring speeds along the pins, and close to the rotor almost no speed at all.

This will provide a short-circuiting path for pulp, or dry material, subjected to very little grinding.

Since pin and media wear are highly influenced by the pin speed, this should be kept as low as possible, but still sufficiently high for efficient grinding. There is in most cases an optimum speed, at which the combined costs for media wear and power will be minimum. Any deviation from this will increase costs, but this optimum is to our knowledge not very steep, so absolute optimum can only be achieved by longtime operation with variable speed drive. Other equally influential factors are the media size and cost, as well as local power price.

We have operated the 7.5 kW pilot mill with media sizes in the range of 2 - 15 mm, and with pin tip speeds of 2 - 5 m/s and with media of steel, steatite and alumina. For a ten-time scale-up to 75 kW mill powers we have found no deterioration in results, i.e. with scale-up factor 1.0 for geometrically equal conditions. This was in line with our expectations.

We have also found that there is a lower limit on charge height under which short-circuiting of coarse material occurs. This is more pronounced for dry grinding.

Using a too big mill running at a low charge level is thus not recommendable.

The mills can be operated both wet and dry, continuous or batch-wise. For continuous wet grinding feed pulp is pumped or gravity fed at the bottom of the mill and overflowing at the top. See fig. 1. As media have been used steel balls or cylpebs from three to twelve mm diameters, and also steatite or alumina media of equal sizes.

Also the mills are very energy intensive. They will draw ab. 40 kW/t steel media, against only ab. 10 kW/t for a tumbling mill. Resulting mill volume per kW will be only ab. 1/10 of that for a ball mill!

For dry grinding material is fed at the top of the mill and flows through the mill by gravity, to be discharged through a bottom grate plate and collected underneath the mill. Material level in the mill is checked by a level probe and regulated by the sluice type feeder under the mill. Note, that no blow or suction air is necessary in the mill! Dry mills will not be further dealt with in this paper.

Noise level is well under 85 dB(A), so the mills can be operated in areas where people are working without ear-muffs.

Since the drive reaction torque is transferred to the tank shell, and the stirring action is basically horizontal, the mill can in principle be placed on any flat surface strong enough to carry the total weight. However, in practical operation it should be elevated at least half a metre by some stand or support, to facilitate dumping of the media charge as needed.

For regrinding in existing plants this means that an agitated mill can be installed where it is needed, and in this way avoiding long pump lines to the existing grinding bay.

In principle then can be used one mill for the scavenger concentrate and another for the middlings, if particle size requirements are different for these.

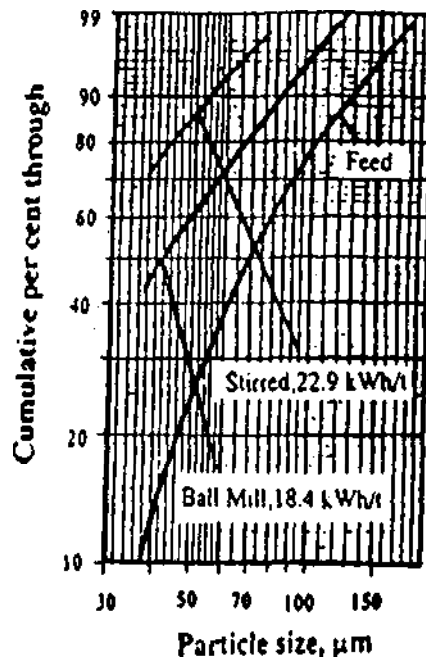

Fig. 2. Tumbling mill stirred mill comparison

4. TESTS AND OPERATING RESULTS

The advantages described above should make agitated mills an interesting alternative, even if grinding efficiency should turn out to be comparable with conventional tumbling mills. However, as will be shown below, substantial improvements in power consumption as well as "tailored" mill flowsheets are in general possible.

Table 1. Comparison of Regrind Mill Performance

	Power, kW	%-3&fan	WI, kWh/t
BALL mill -38 mm slug	30.5	1.7	84.0
BALL mill - 8 mm slug	35.5	3.6	42.5
SAM* graded charge	21.1	4.4	11.4

* Graded charge made up of 3/8", 5/8" and 8x8 mm cylpebs

Ball mills are notoriously inefficient for wet regrinding, as also evident from the Bond correction factor EF7 (low reduction ratios), which can get very large for such applications. Basic Work Indices from a number of North European plants calculated less the above factor, show values of 25 to >100.

This is also verified by the enclosed results from a pilot test with an agitated mill running parallel with a full scale ball mill. Feed was a spiral tailing and thus well deslimed, as can be seen in fig. 2. Also one can see that the agitated mill is much more energy efficient.

The agitated mill was run at several different feed rates with resulting different sp.power consumptions. The operating Bond Work Indices calculated without correction factors was 80.6 kWhA for the conventional mill against 18.4 kWh/t for the agitated mill. Very similar ratios are shown by Ref. 1 in table 1 above with about 1:4 ratios between operating WI!

Another interesting conclusion can be made from these tests. The "fraction production" at the coarser end of the size distribution, in this case 60 to 100 μ m, is as much as five times as big as that for the higher power consumptions, while it is comparable at - 20 μ m.

One natural explanation to this is of course that when a fraction is completely depleted, it will be penalized by such a way of calculation. Nevertheless, for regrinding of middlings the desired action is to selectively break the coarse interlocked particles, without producing too much fines. Figure 3 then indicates a method to accomplish this by running two or more agitated mills in series as needed in order to keep the sp. power consumption down per stage and concentrate the grinding to the coarser fractions.

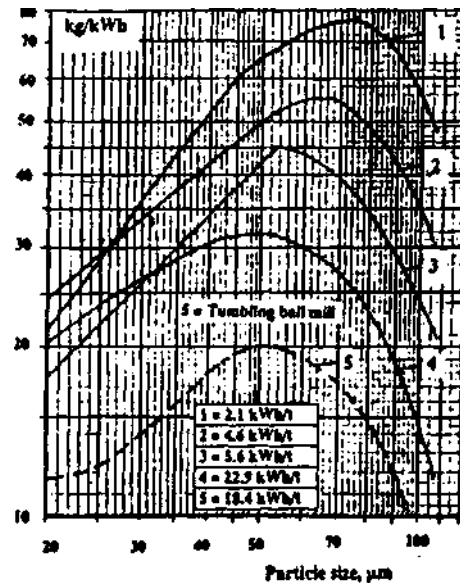

Fig. 3 Production per fraction

This is feasible with agitated mills, but not with ball mills. The reasons for this are that the agitated mills are small and "energy dense", so that two or three units still will not occupy too much space, and also that the price scale factor is low, i.e. two smaller mills will not be considerably more expensive than one big mill for the same power.

For most concentrating circuits, especially flotation circuits, recirculated products, such as middlings and circulating loads, are fluctuating rapidly in tonnage and pulp densities. This hampers the possibility of efficient regrinding, since ball mills are sensitive to low pulp densities and need to be operated in closed circuit with classifiers, mostly hydrocyclones. The problem then is that the cyclones are volume dependent, so for real efficient regrinding the number of cyclones should be varied as needed, and pump capacity regulated accordingly. This is rarely made in practice with the result of running the mills in open circuit with very inefficient results.

If then the agitated mills could operate in open circuit and still grind fairly efficient and with acceptable "tramp oversize" control, it would be ideal for this application. As evident from fig 4 and 5 indeed it does! This is the result of a full scale regrind plant test in a Swedish concentrator. Feed was a middling with ab. 15 w/w % solids (!), spec, power consumption ab. 2.75 kWhA, and retention time in the mill ab. 15 seconds.

As can be seen, the mill discharge has a slightly steeper slope than that of the feed, indicating good internal classification. Also efficiency is still high with an operating WI of less than 20 as compared with the secondary ball mill WI of ab. 15. Fig. 5 shows that the mill predominantly grinds in the 50 - 100 μ m range, but also still with good capacity on the finer fractions.

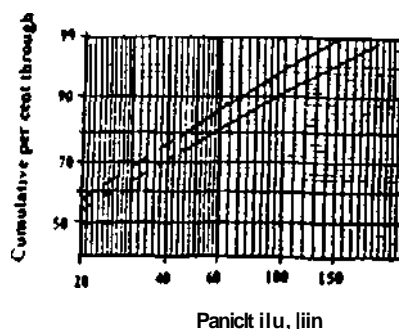

Fig. 4 Re ground particle size distribution, stirred mill

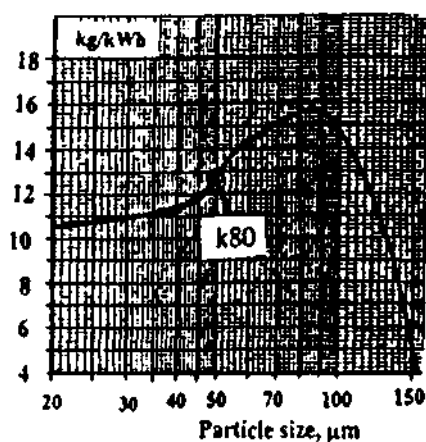

Fig. 5 Regrinding production per fraction

From the above can then be established that agitated mills are perfectly suited as regrind mills, and as such there will be virtually thousands of applications in existing and new concentrating plants.

However, they can also be used as secondary or tertiary mills for very fine grinds, and then in open circuit because of the inherent good classification.

Fig. 6 shows the result of fine grinding on an Australian sample where the desired product size was k80 10 - 12 Jim. The pilot tests were made in steps in order to bracket these sizes. Most interesting here, was the resulting parallel straight lines in the screen diagram, confirming the good internal classification, i. e. that a closed circuit would not have improved particle size distribution appreciably, and also that fines production was low. High fines production would have resulted in a gradual flattening of the curve, while in reality the slope is better than for the feed also for the finest grinds!

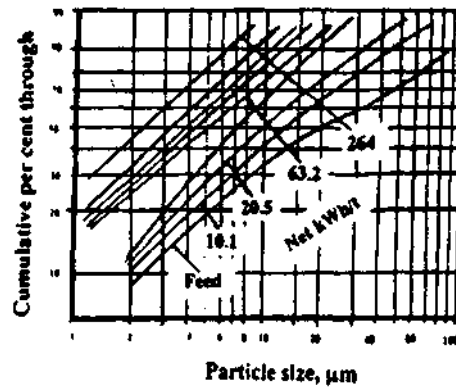

Fig. 6 Batch grinding at various sp. powers

There are already published other confirmations on the sort of improvements to expect by replacing ball mills with agitated mills for fine grinding. Ref. 2 is in Fig.7 making similar claims on improved mill efficiencies as what we have done above.

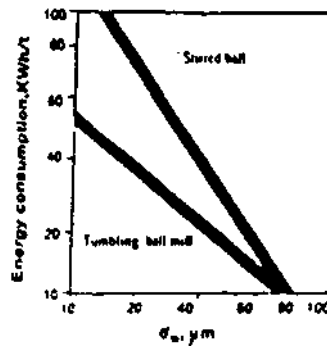

Fig 7 Energy-size relationships for a stirred and tumbling mill

Until date there are some twelve units of our design from 7.5 kw to 75 kW installed motor power delivered or in order. The oldest mill has been running continuously for more than two years. Media wear is very much depending on tip speed, but at least for the lower tip speeds it seems to similar to that in ball mills, when reported as g/kWh.

Smallest commercially available steel media (at least with reasonable prices) are 8 - 10 mm balls or cylpebs. They are suitable for grinds down to 20 - 30 μ m, and the cost is ab. twice that of 25 mm steel balls.

This means that media wear costs should be of the same magnitude as for a corresponding ball mill. Then the cost advantage will be less power consumption and maintenance, and of course an improved ground product from metallurgical point of view. Investment cost per "efficient" kW is also less.

The principal design of our wet mill is shown in Fig. 1. From wear and maintenance point of view should be noted that the rotor is cast in a hard heat-treated alloy with bottom part and lifters/pins in solid tungsten carbide. The body has a number of vertical baffles to act as "rock-boxes" and forming a protective wall of settled media. This means that Wall wear will be media against media, and there is virtually no wear on the body wall itself.

5. CONCLUSION

Based on the above evidence it appears to the authors of this paper to be proven that for efficient regrinding of middlings and /or fine wet grinding of also hard and abrasive minerals, vertically stirred ball mills will be the currently most efficient method.

For larger capacities and powers already another type of vertical stirred ball mill exists with powers up to 800 kW. It is the Tower/Vertimill type. This cannot quite match the grinding performance of the SAM-mill because of inherent less active zones in the mill. However, it certainly also outperforms conventional ball mills, with reported improvements of 35 - 40 % for regrinding duties. For new plants needing larger regrinding one-stage mills, this is probably the best solution available, but the bulk and height of these mills make them less suitable for retrofitting into existing buildings and plants.

Also for dry grinding stirred mills show equal promise, but here the high-pressure roller mill will be a contender, at least for product sizes larger than ab. 5 μ m and not too abrasive materials.

ACKNOWLEDGEMENT

The authors want to thank the Denver-Sala management for permission to publish this material, as well as various people from Scandinavian Institutions and companies for private communications used here, and to be officially published by them later.

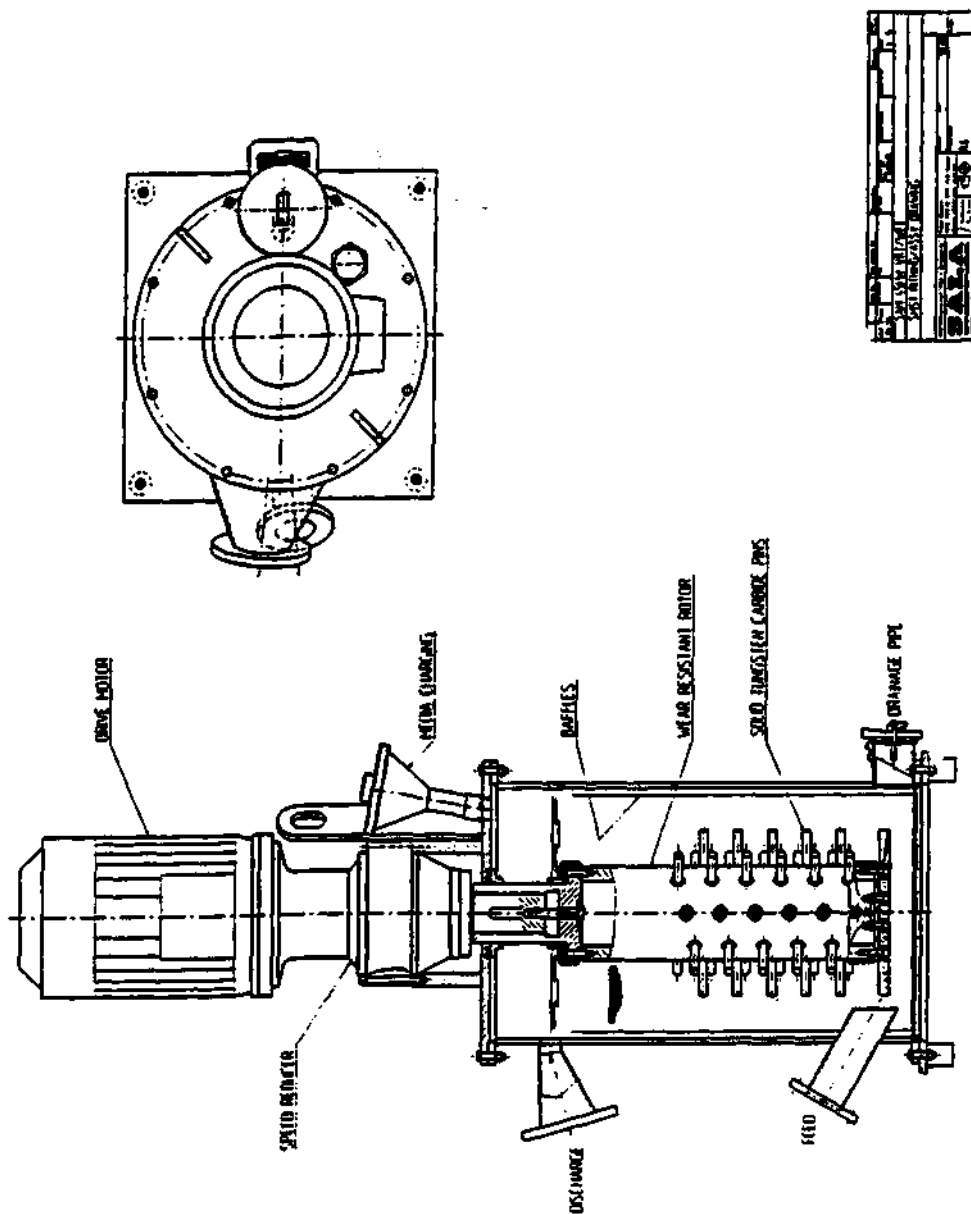

Fig 1. Principle design of the SAM-mill

7. REFERENCES

1. Proc. 25th Annual Meeting of the Canadian Mineral Processors, Ottawa 1993
2. MINTEK Bulletin No. 56. Dec. 1992